

A Ø6*30 X6	B X2	C ST4*30 X6	D ST4*30 X4	E ST4*10 X6	F X2	G X2	H X2
I ST4*16 X4	J X1	K X3	L X1	M X2	N X2	O X1	P X1
Q X2	R X1	S X1	T X1				

Ex6

ST4*10

Nx2

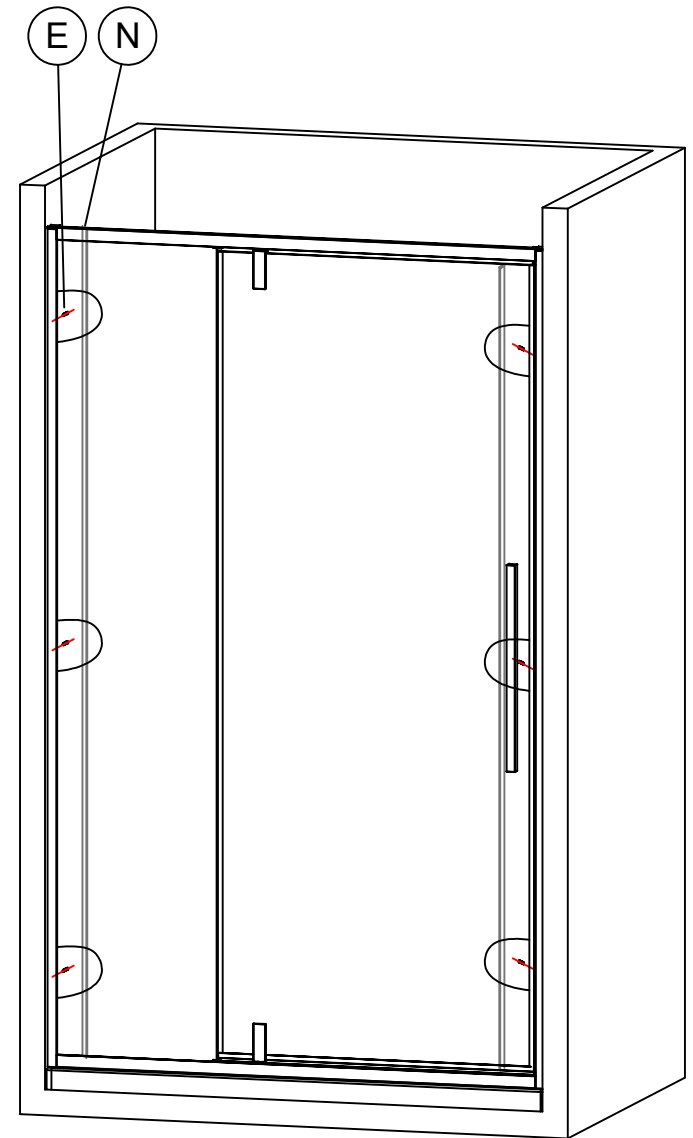

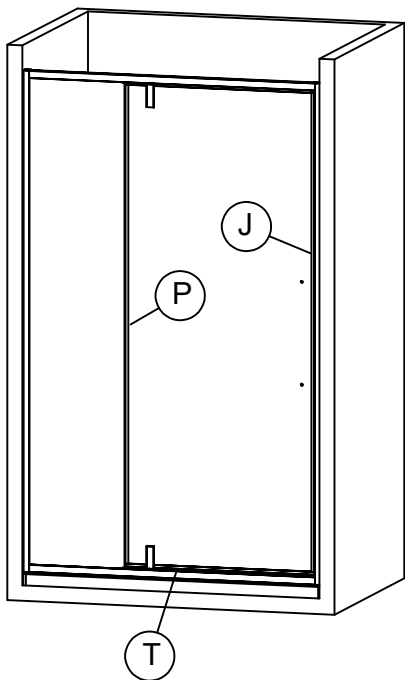
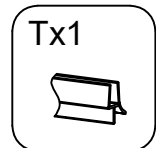
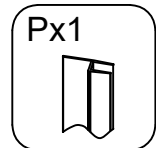
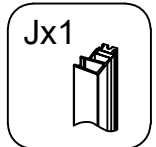

7

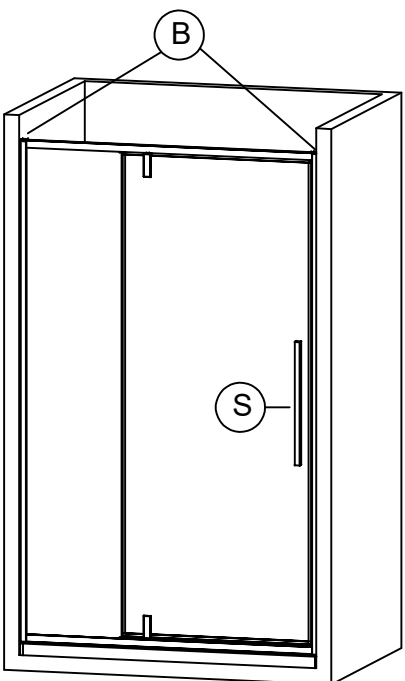
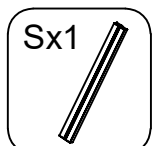
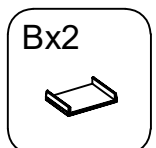

8

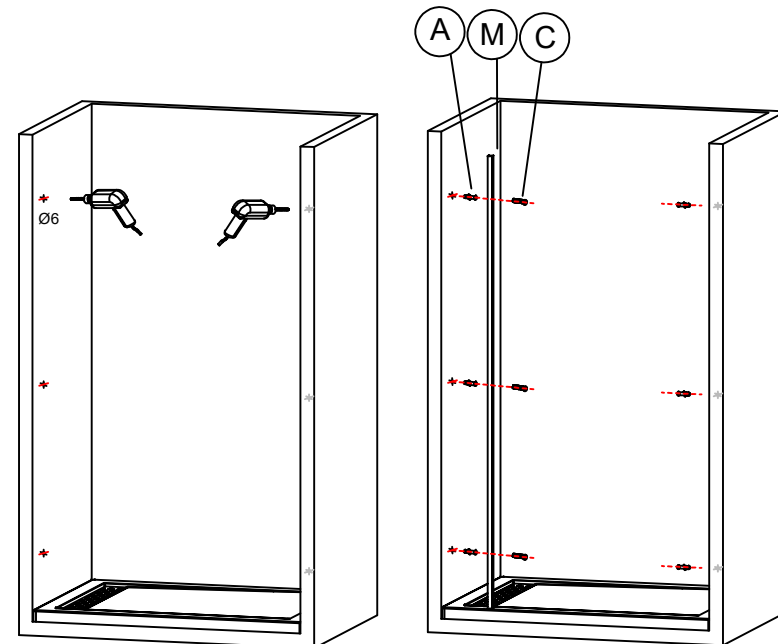
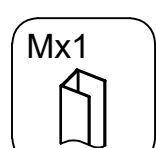

1

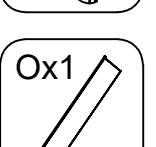
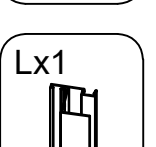
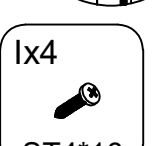
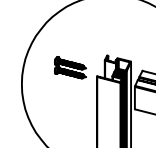
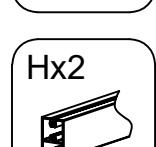
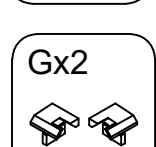
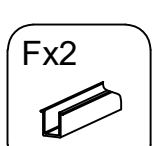

2

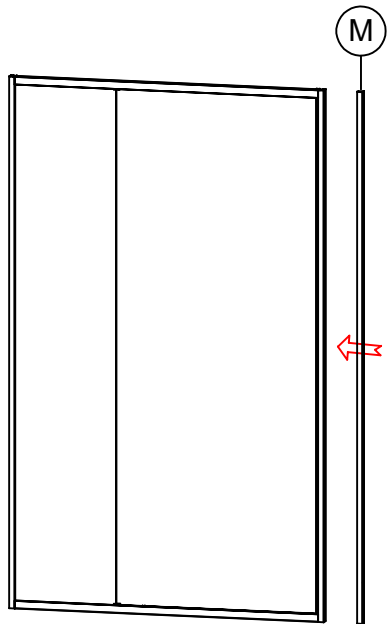

3

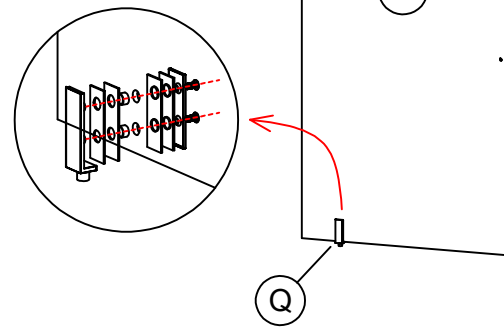
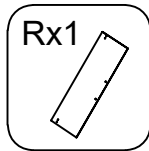
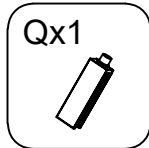

5

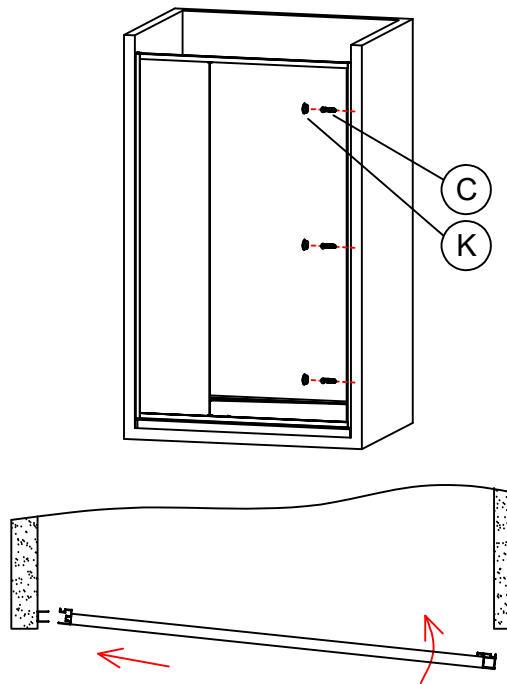
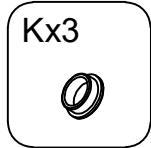

4

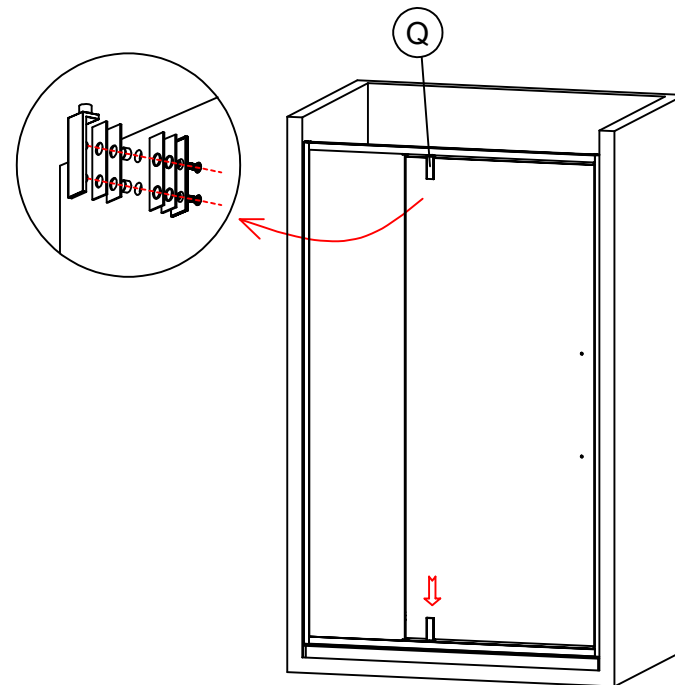
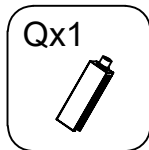

6