

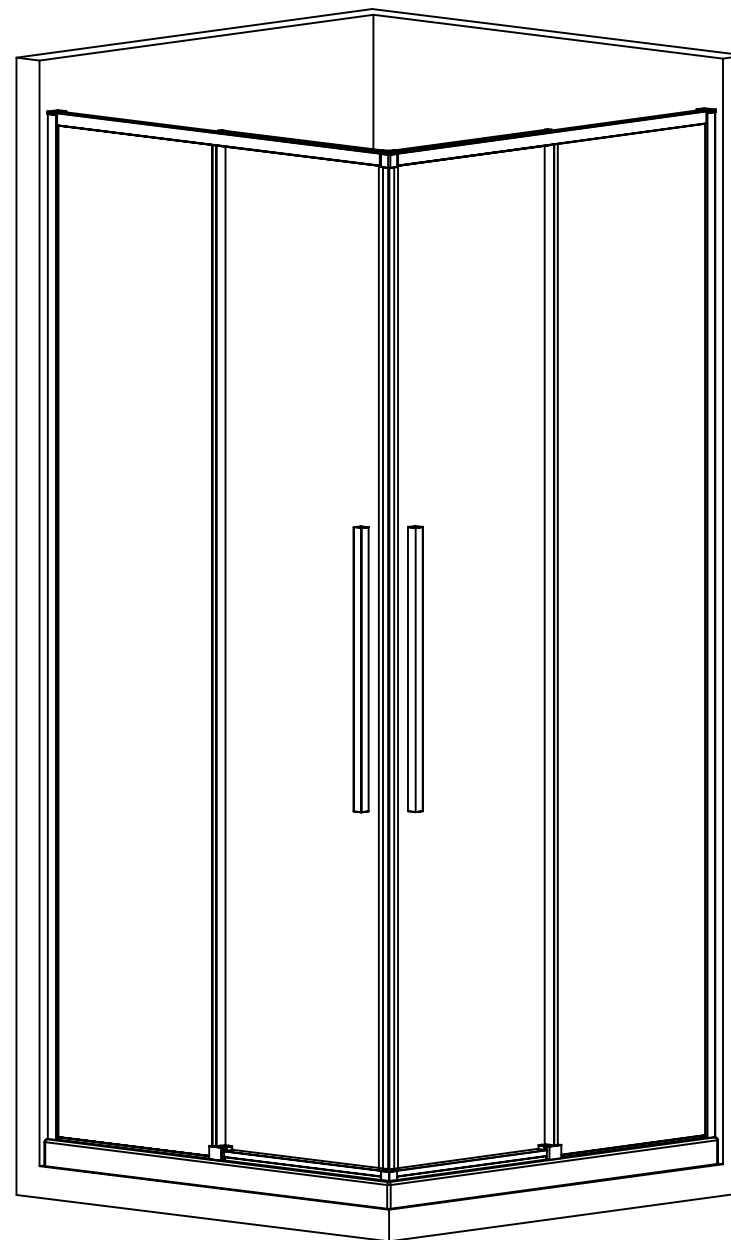

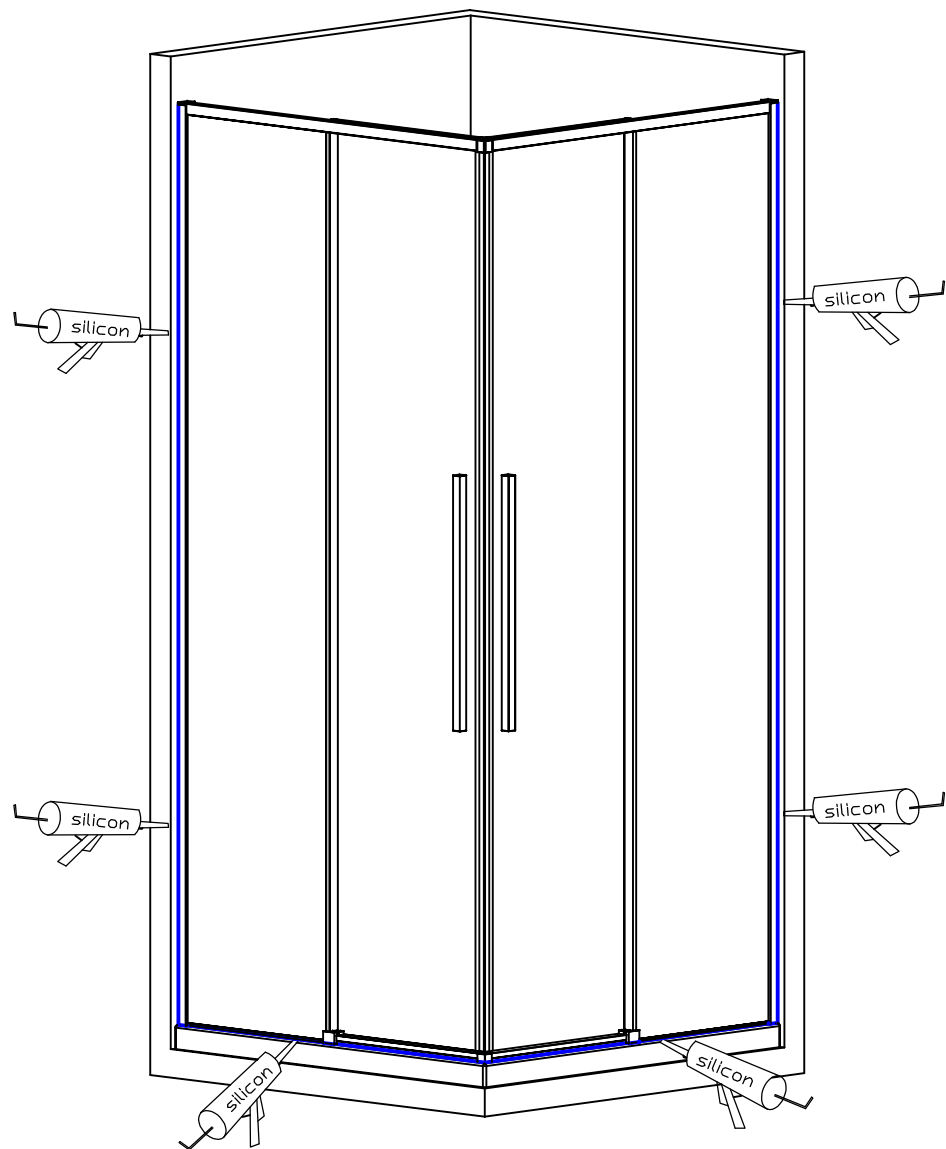

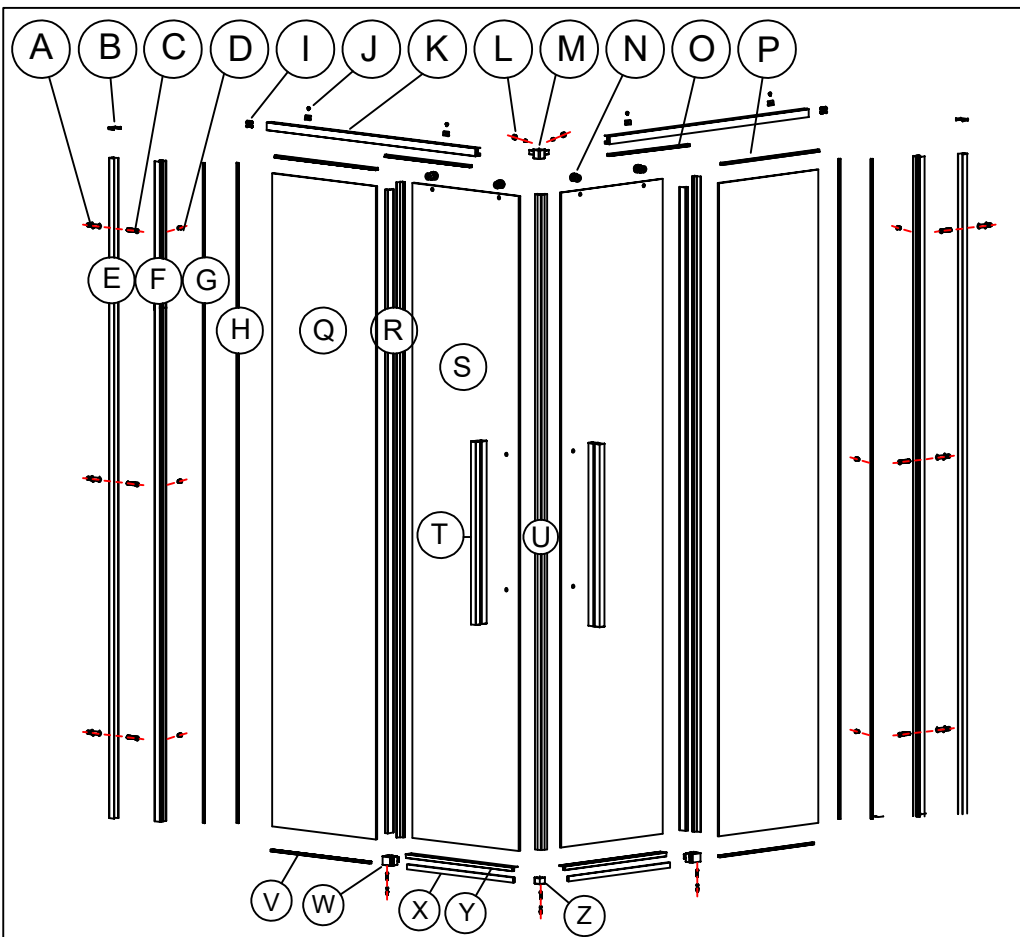







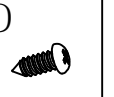
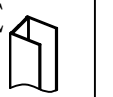
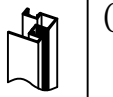





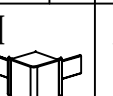

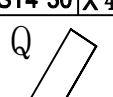

**Diplon**

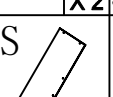
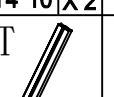
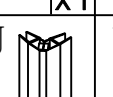

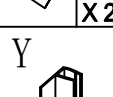
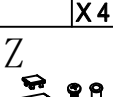

 Ø6*30 X 6	 X 2	 ST4*30 X 6	 ST4*10 X 6	 X 2	 X 2	 X 2	 X 2
 ST4*30 X 4	 ST4*10 X 4	 X 2	 ST4*10 X 2	 X 1	 X 4	 X 2	 X 2
 X 2	 X 4	 X 2	 X 2	 X 1	 X 2	 X 2	 X 2
 X 2	 X 1						

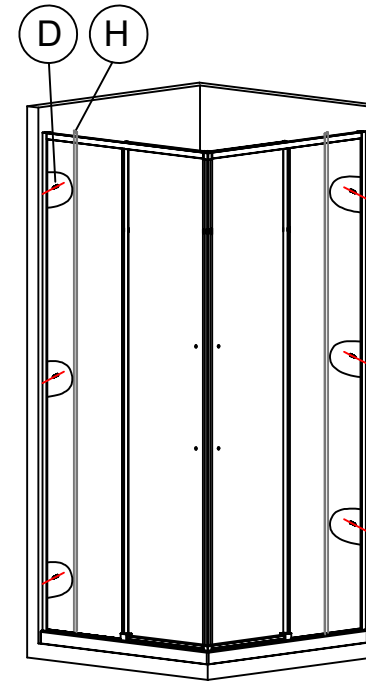
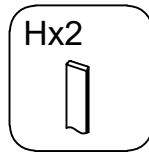
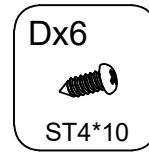

9

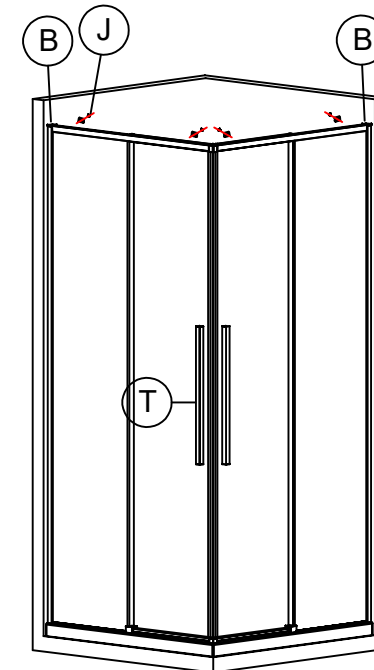
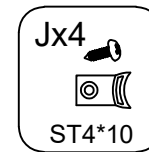
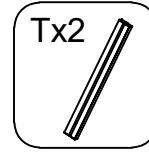
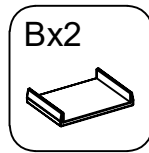

10

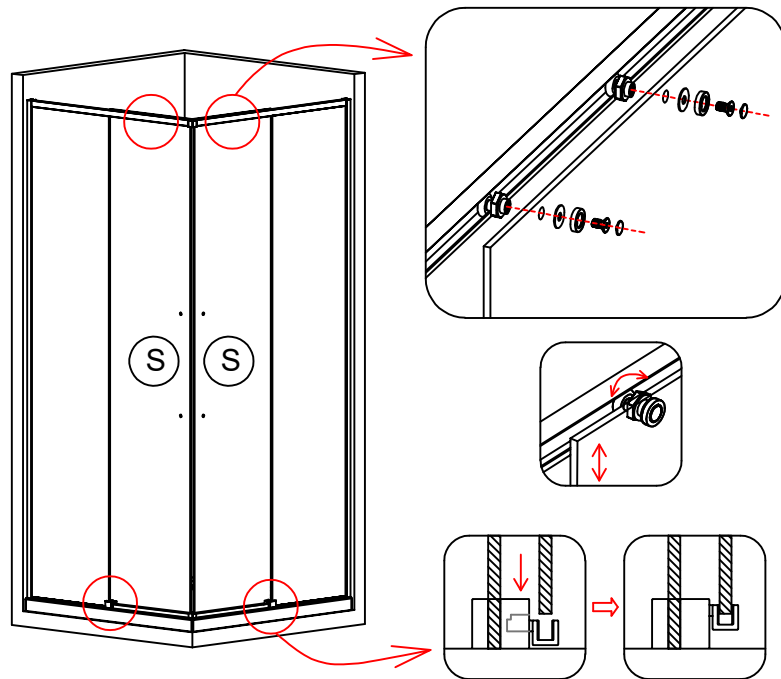
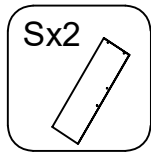
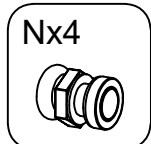

7

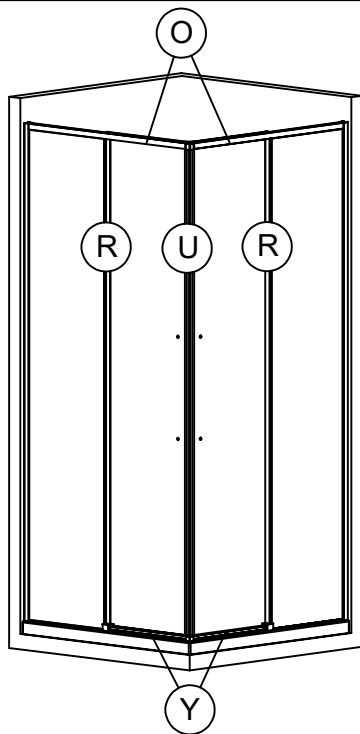
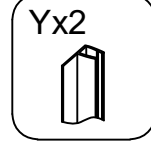
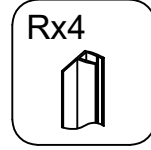
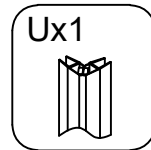

8

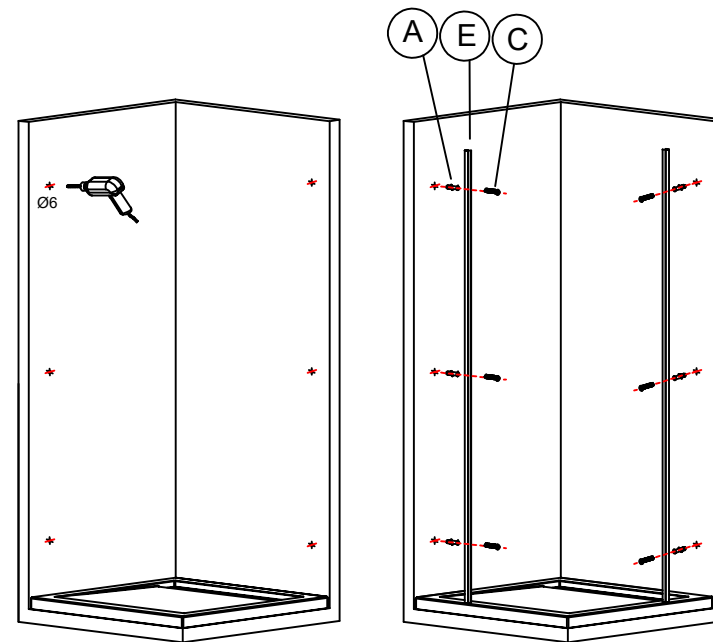
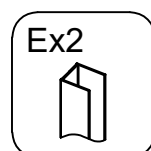
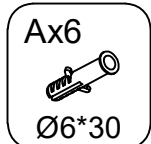

1

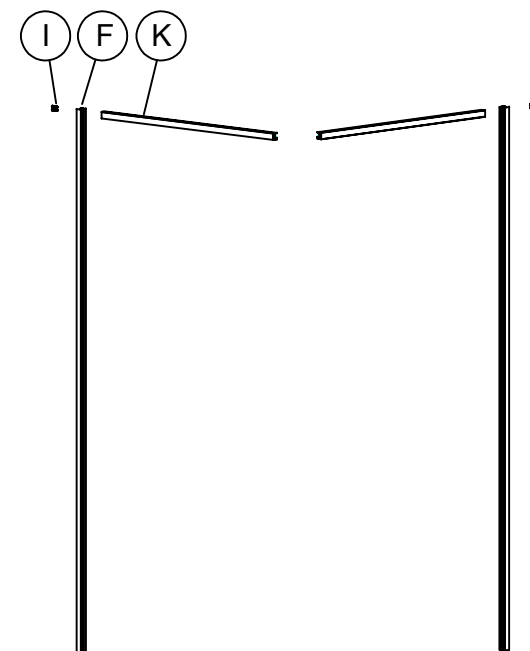
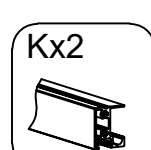
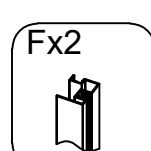

2

3

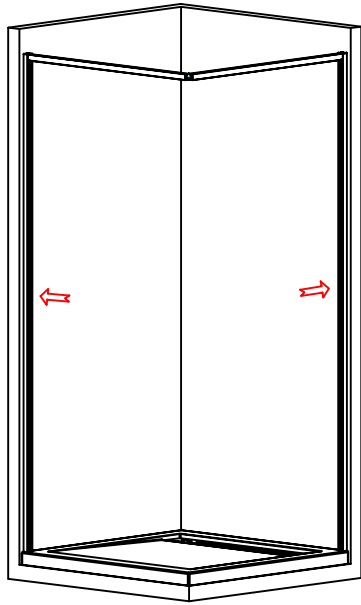

4

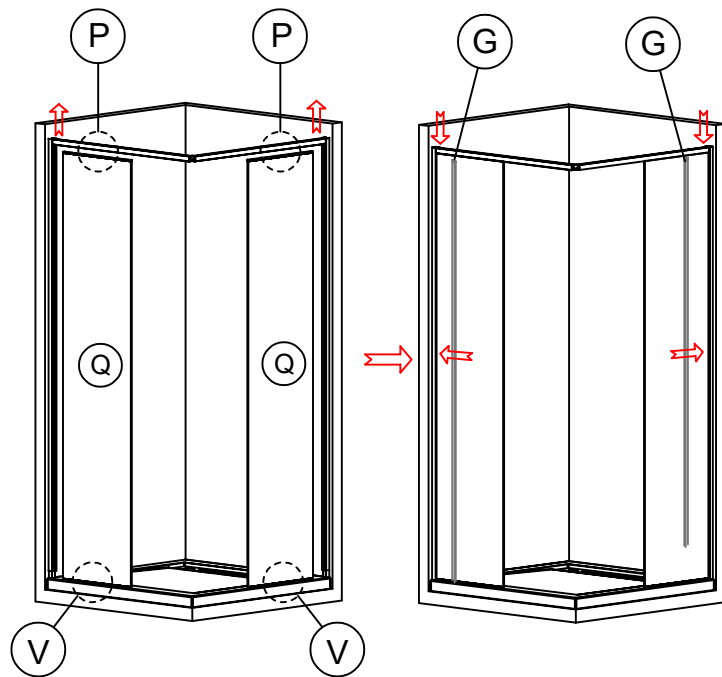
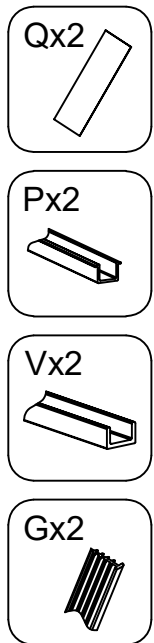

Mx1



Lx2



ST4\*10

5

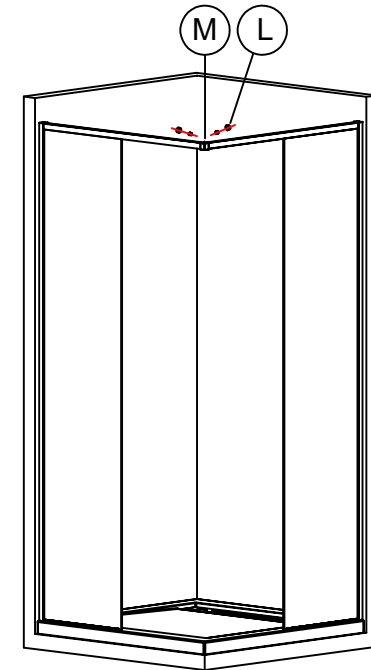

Wx2

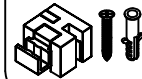

Xx2



Zx1

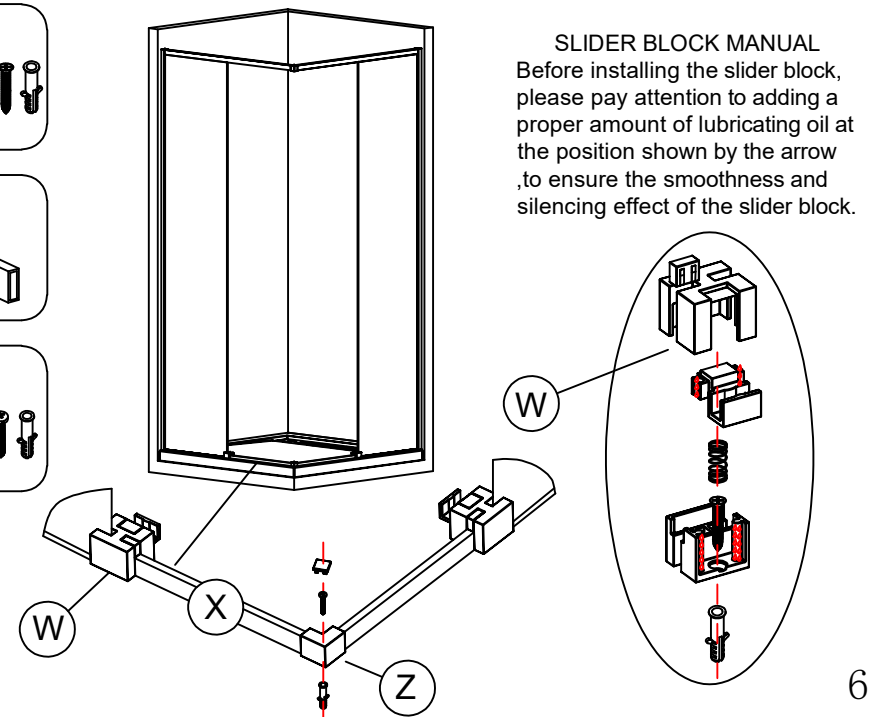

**SLIDER BLOCK MANUAL**  
 Before installing the slider block, please pay attention to adding a proper amount of lubricating oil at the position shown by the arrow, to ensure the smoothness and silencing effect of the slider block.

6